

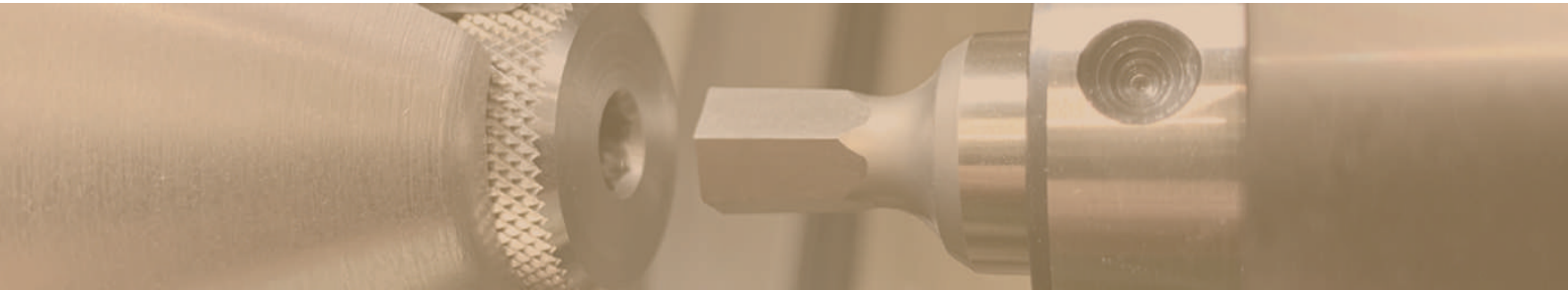





## TECNOLOGÍA DE BROCHADO

## ROTARY BROACHING TECHNOLOGY





		Página Page
	► <b>Información técnica sobre brochado rotatorio</b> Technical information about rotary broaching	1
	► <b>Cabezales de brochado</b> Rotary broaching heads	
	• Mango cilíndrico ..... Cylindrical shank	7
	• Mango Weldon ..... Weldon shank	8
	• Mango Morse ..... Morse shank	9
	• Mango VDI ..... VDI shank	10
	► <b>Punzones</b> Broaches	
	• Punzones hexagonales ..... Hexagonal broaches	11
	• Punzones hexagonales en pulgadas ..... Hexagonal broaches	12
	• Punzones cuadrados ..... Hexagonal broaches	13
	• Punzones hexalobulares ..... Hexagonal broaches	14



# BROCHADO ROTATORIO

## ROTARY BROACHING



### 1.Introducción

El brochado rotatorio es un sistema sencillo, rápido y económico de mecanizar perfiles poligonales (cuadrados, hexagonales, estriados...) tanto interiores, ciegos o pasantes, como exteriores sobre pieza de los más diversos materiales.

El principio de funcionamiento es simple. El eje del elemento de corte (punzón o matriz) está desviado 1° respecto del eje de giro de la pieza a mecanizar, así como del eje del cabezal. Esta diferencia de ángulo hace que el elemento de corte gire ejecutando un movimiento oscilatorio que provoca un cizallado progresivo según se profundiza en la pieza. Ese cizallado reproduce fielmente sobre la pieza el perfil del elemento de corte utilizado.

El elemento de corte tiene un ángulo de desprendimiento de 1,5° de manera que corte solamente con la arista. Si el ángulo es igual o inferior a 1° el elemento de corte talona y no corta adecuadamente, lo que provoca una mala calidad de las caras de corte. Si por el contrario el ángulo es superior a 1,5° lo que hacemos es aumentar la fragilidad.

Las ventajas del brochado rotatorio son:

- Extremadamente rápido y preciso
- Reduce el tiempo de mecanizado
- No se requiere operaciones secundarias
- Gran calidad de acabado

El brochado rotatorio permite en muchos casos la realización de perfiles poligonales en torno, centro de mecanizado y/o taladro, sustituyendo los procesos de electroerosión o punzando en prensa, lo que se traduce en un ahorro importante de tiempo y dinero.

### 2.Brochado en torno / en centro de mecanizado

Los cabezales de brochado tipo "POLIPROFILE" fabricados por INTEG I pueden ser utilizados tanto en tornos como en centros de mecanizado y/o taladros.

El movimiento pendular generado por el cabezal se produce cuando el punzón gira con relación al cabezal de brochar.

Ese giro puede ser provocado de dos maneras:

- En torno: Cuando se trabaja en un torno (que no tenga torreta motorizada), el cabezal de brochado está estático montado en la torreta del torno y la pieza gira en el plato. Cuando el punzón/matriz se clava en la pieza este comienza a girar junto con la pieza realizando el movimiento pendular.
- En un centro de mecanizado y/o taladro: Cuando se trabaja en un centro de mecanizado y/o taladro, es la pieza la que está estática amarrada en la mesa de la maquina y el cabezal gira montado en el husillo. Cuando el punzón/matriz se clava en la pieza este se queda quieto, pero el cabezal sigue girando lo que provoca el movimiento pendular característico de este tipo de cabezales.

### 1.Introduction

The rotary broaching is a simple, fast and economic system to machine polygonal shapes (square, hexagonal, six lobe, splined shafts...) in a wide variety of materials.

The operating principle is a simple. The axle of the broach is divert 1° from the axle of rotation of the workpiece. This angle difference makes the broach rotate executing an oscillatory movement which cut's the material reproducing accurately the shape of the broach used.

The broach has a 1.5° clearance angle so it cuts only with the edge. If the angle is equal or lower than 1° the broach does not cut properly, causing poor quality of the faces. If the angle is bigger than 1.5° the broach fragility increases.

The advantages of rotary broaching are:

- Extremely quick and accurate
- Reduces machining time
- No secondary operations required
- Great finish quality

Rotary broaching allows in many cases the execution of polygonal profiles in lathes, machining centers or drilling machines. It replaces the use of electrical discharge or stamping presses which saves a lot of time and money.

### 2.Broaching in lathe or machining centre

"POLIPROFILE" toolholders manufactured by INTEG I can be used on lathes, machining centers or drills. The wobbling movement appears when the toolholder gets in contact with the workpiece, being one static and the other turning. It can be produced in two different ways:

- Lathe: While working with a lathe, the tool holder, fixed on the turret (which does not have a live turret), stays static while the workpiece turns on the chuck. When the broach/die nails the workpiece, it starts rotating with the workpiece with the so-called wobbling movement.
- Machining center/drilling machine: While working with a machining center or a drilling machine, the workpiece is tied up to the machine table and the toolholder is turning clamped in the spindle. When the broach/die nails the workpiece, it stays static, but the toolholder keeps turning which produces the wobbling movement.



## BROCHADO ROTATORIO ROTARY BROACHING



### 3. Brochado interior / exterior

Los cabezales de brochado tipo "POLIPROFILE" fabricados por INTEGI se pueden utilizar indistintamente para la realización de brochados tanto en ejes como en agujeros. La misma cabeza puede ser empleada en ambas aplicaciones, si bien para la realización de brochados exteriores se ha de utilizar un adaptador para poder sujetar la matriz.

En brochados interiores se usa un punzón con el perfil a brochar. En brochados exteriores es necesario el uso de una matriz de corte y portamatrix.



### 3. Internal and/or external broaching

INTEGI'S POLIPROFILE Toolholders can be used for both internal and external rotary broaching. The same toolholder can be used for both, although in the case of external broaching an adapter is necessary to hold the die. In the case of internal broaching, you have to use a broach with the required profile. In external broaching you need a cutting die and a die-holder.

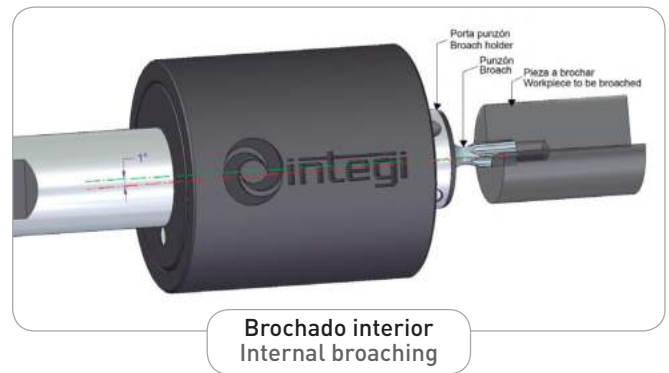

#### 3.1 Preparación de la pieza para brochado interior

Para la realización de un brochado interior se ha de usar un punzón con el perfil concreto que se desea obtener en la pieza.

A la hora de realizar un brochado interior, es importante tener en cuenta las siguientes recomendaciones:

1. Colocar el punzón en el cabezal rotatorio y asegurarse de su correcto centrado, para lo cual será necesario la ayuda de un reloj comparador.
2. Mecanizar un agujero con un  $\phi D3$  igual o ligeramente superior al diámetro mínimo del perfil a brochar. En el caso de punzones poligonales (hexagonales, octogonales, cuadrados...) el  $\phi$  diámetro a taladrar  $\phi D3$  ha de ser igual o superior a la medida entre caras del punzón.
3. El agujero ha de ser 1.5 veces más profundo que la (L) longitud total del brochado. Esto es necesario para poder alojar las virutas desprendidas.
4. Realizar un bisel de  $90^\circ$  en el agujero para facilitar el enclavamiento de la matriz en la pieza al contacto con ella. El  $\phi$  máximo del bisel  $\phi D2$  ha de ser igual o superior al  $\phi D1$  circunscrito del perfil a brochar. En el caso de punzones poligonales (hexagonales, octogonales, cuadrados...) el  $\phi D2$  máximo del bisel ha de ser igual o superior a la medida entre aristas del punzón  $\phi D$ .
5. La longitud máxima a brochar recomendada no puede exceder de 1,5 veces el  $\phi D3$  diámetro interior del perfil a brochar.

#### 3.1 Preparing the workpiece for internal broaching

For the execution of internal rotary broaching, you need a broach with the profile you want to get on the workpiece. It is important to take into account the following recommendations:

1. Place the broach on the toolholder and make sure it is correctly centered by using a dial test indicator.
2. Machine a hole with a  $\phi D3$  equal or slightly bigger than the minimal  $\phi$  of the profile to be broached. In the case of hexagonal, octagonal or square broaches, the  $\phi$  to be drilled  $\phi D3$  needs to be equal or bigger than the distance across flats A/F.
3. The pre-drilled hole needs to be 1,5 times deeper than the desired depth of cut (L) for chip clearance.
4. Make a  $90^\circ$  countersunk for broach lead. The maximum  $\phi$  of the chamfer  $\phi D2$  needs to be equal or larger than the circumscribed diameter  $\phi D1$  of the profile to be broached. In the case of hexagonal, octagonal, square broaches, the  $\phi D2$  of the countersunk needs to be equal or larger than the distance across edges  $\phi D1$ .
5. The maximum recommended depth of cut should not exceed 1,5 times the  $\phi D3$  interior diameter to be broached.

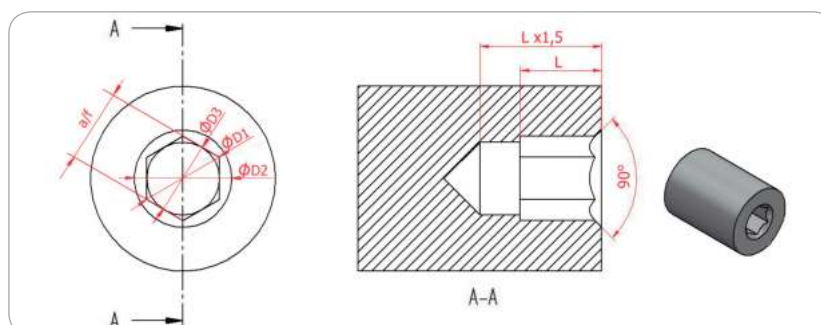





## BROCHADO ROTATORIO ROTARY BROACHING



### 3.2 Preparación de la pieza para brochado exterior

Para la realización de un brochado externo, el lugar de una brocha o punzón, se necesita una matriz de corte la cual va montada en un portamatriz. El conjunto portamatriz+matriz va a su vez ajustado en la parte frontal del cabezal rotatorio y amarrado mediante espárragos roscados.

Los portamatrices son elementos estándar diseñados específicamente para cada modelo de cabezal.

A la hora de realizar un brochado exterior, es importante tener en cuenta las siguientes recomendaciones:

1. Colocar el conjunto matriz+portamatriz en el cabezal rotatorio y asegurarse del correcto centrado de la matriz, ayudándose de un reloj comparador.
2. Tornear la pieza a brochar hasta un diámetro exterior  $\phi D1$  igual al diámetro circunscrito (máximo) de la figura a brochar.
3. Realizar un bisel de  $45^\circ$  en cara frontal de la pieza a brochar, que facilite el enclavamiento de la matriz en la pieza al contacto con ella. El  $\phi D2$  diámetro mínimo del bisel ha de ser igual o inferior al diámetro inscrito del perfil a brochar  $\phi D3$ .
4. La longitud máxima a brochar recomendada no puede exceder de 1,5 veces el diámetro interior del perfil a brochar  $\phi D3$ .
5. No se puede brochar hasta una pared. Al final del brochado se recomienda hacer un canal (L1) de 1,5-2 mm de anchura y hasta un diámetro  $\phi D4$  inferior al diámetro inscrito del perfil a brochar  $\phi D3$ . Esto permitirá que las virutas se desprendan una vez que la matriz llegue al canal.

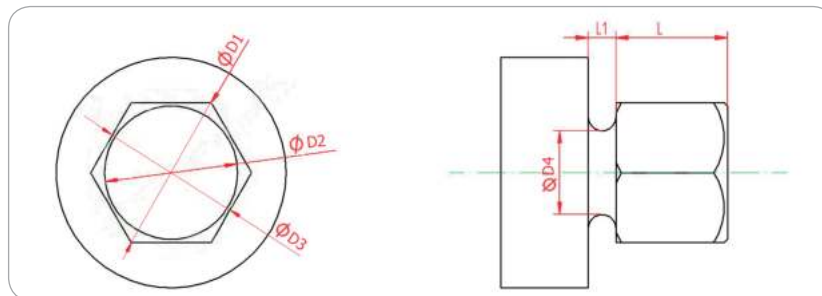

### 4. Recomendaciones de rpm y Av.

La velocidad de giro no tiene mucha relevancia ya que la brocha gira junto con la pieza. Sin embargo, comenzar a brochar a alta revoluciones tiene a tornear la entrada del agujero y puede llegar a dañar la brocha.

Los valores de velocidad y avance dependen de varios factores, entre otros la dimensión del punzón/matriz, el material a brochar y la dimensión previa al brochado. Como orientación se recomienda trabajar entre 500-1000 rpm y con un avance de entre 0.05 – 0.1 mm/vuelta.

Si se avanza excediendo ese ángulo, el punzón o matriz no corta sino que arranca el material, dejando mala calidad y provocando un desgaste excesivo.

Al comienzo del brochado es recomendable reducir la velocidad todo lo posible hasta asegurar que la herramienta (brocha/matriz) esta clavada en el bisel generado en la pieza, y tanto pieza como herramienta giran simultáneamente. Esto evita que la pieza golpee la herramienta a mucha velocidad y previene posibles roturas de las esquinas de la herramienta. Clavar la brocha ligeramente en la pieza con esta totalmente parada esta también permitido. Una vez que la pieza y la herramienta giran simultáneamente, incrementar la velocidad de giro hasta los valores recomendados. Nunca retirar la herramienta en avance rápido. Usar el mismo avance tanto para la entrada de la herramienta como para la retirada de esta.

Es imperativo el uso de abundante refrigeración sobre la zona de trabajo aplicada directamente a la zona de corte. Este punto es muy importante en el caso de brochados interiores.

### 3.2 Preparing the workpiece for external broaching

For the execution of external broaching, a cutting die is needed instead of a broach. It is assembled to a die-holder. This set is, in its turn, fixed to the front side of the toolholder and screwed by threaded studs.

The die-holders are specifically designed for each model of toolholder.

It is important to take into account the following recommendations:

1. Place the set die-holder+die on the toolholder and make sure it is correctly centered with the help of a dial test indicator.
2. Turn the piece to be machined to an exterior diameter  $\phi D1$  equal to the maximum circumscribed diameter of the profile.
3. Make a  $45^\circ$  chamfer on the front side of the workpiece for broach lead. The diameter of the chamfer  $\phi D2$  has to be equal or smaller than the inscribed diameter of the profile to be broached  $\phi D3$ .
4. The maximum recommended length (L) of cut should not exceed 1,5 times the circumscribed diameter of the profile  $\phi D3$ .
5. It is not possible to broach up to a wall. It is recommended to machine a groove (L1) of 1,5-2 mm wide at the end to allow chip clearance. The diameter  $\phi D4$  of the groove should be smaller than the inscribed diameter of the profile  $\phi D3$ .

### 4. Speeds and feeds

The speed does not have much relevance because the broach rotates together with the workpiece. However, starting to broach at high speed may turn the material and can damage the broach.

Speeds and feeds depend on several factors, such as the size of the broach/die, the material of the workpiece and the pre-drill diameter. We recommend to work between 500-1000 rpm at a feed rate of 0,05 mm-0,1 mm/turn.

Faster feeding makes the tool tends to tear the material instead of cutting it, causing poor quality and excessive wearing.

When you start broaching, it is good practice to start at a low speed until you make sure the die/broach is pinned to the chamfer of the workpiece so workpiece and tool turn simultaneously. This keeps the workpiece from hitting the tool at a high speed which could break the corners of the tool. You can also nail the broach to the workpiece lightly, being the workpiece completely static.

Once both workpiece and tool are turning simultaneously, you can increase the turning speed to the recommended values. Never move away the tool at a high feed. Use the same feed value at the beginning and at the end of the process.

It is imperative to use any kind of coolant directly to the cutting area, especially in the case of internal broaching.



## BROCHADO ROTATORIO ROTARY BROACHING



### 5. Reglaje de la posición del elemento de corte

Para que la ejecución del brochado sea correcta, con una buena calidad y precisión en la forma del brochado, es muy importante que la posición del elemento cortante (punzón o matriz) sea la correcta para cada tipo de cabezal.

La distancia entre la cara frontal de la herramienta (cara de trabajo) y el morro del cabezal ha de ser la marcada en la siguiente tabla:

### 5. Adjusting the position of the broach

For a correct execution of the broaching, with good quality and a precise broached profile, the correct position of the cutting element (punch or die) for each type of broaching head is very important.

The distance between the front face of the tool (working face) and the broaching head nose must be as follows:

**IMPORTANTE / IMPORTANT**

Cabezal Broaching head	*A
Poliprofile 1	15 mm
Poliprofile 2	15 mm
Poliprofile 3	22 mm
Poliprofile 4	25 mm



Posición de la matriz. Cota "A"  
External broach position. "A" size



Posición de la matriz. Cota "A"  
Internal broach position. "A" size

Si la distancia no es la correcta (ya sea por exceso como por defecto) la herramienta no cortará bien pudiendo dar problemas de perfiles poco precisos, demasiado empuje sobre la pieza, agujeros más grandes de lo debido, generación de una hélice conforme el brochado avanza.

En el caso de brochado interior (trabajando con punzón) la regulación de la posición del punzón se hace actuando sobre el espárrago roscado que hay en el fondo del orificio del portapunzón.

Si la distancia es mayor de la requerida, habrá que introducir más el espárrago roscado para que la distancia se acorte.

Si por el contrario la distancia es inferior a la requerida, entonces habrá que girar el espárrago roscado en sentido anti horario para que salga y así aumentar la distancia.

If the distance is not correct (either by excess or by default) the tool will not cut well, and this can cause problems of excessive pressure on the workpiece producing oversize holes and spiralling.

In case of internal broaching (working with a broach) the adjustment of the position of the tool is made by acting on the threaded stud placed in the bottom of the hole of the broach holder.

If the distance is bigger than the required one, it will be necessary to introduce the threaded stud deeper to reduce that distance.

On the other hand, if the distance is smaller than the required one, then the threaded stud must be rotated anticlockwise so that it comes out and increases the distance.



## BROCHADO ROTATORIO ROTARY BROACHING



### 6. Uso de la varilla de posicionado

Cada cabezal de brochar marca POLIPROFILE se suministra con una varilla de posicionado, la cual se ha de utilizar únicamente en los siguientes casos:

#### 1. Cuando es necesario que el perfil brochado esté alineado con alguna parte de la pieza.

La brocha gira libremente dentro del cabezal por lo que la posición del perfil generado en la pieza no se puede controlar si no se utiliza la varilla de posicionado.

#### 2. Evitar la generación de hélices en brochados profundos.

En brochados interiores, cuando la profundidad a brochar es grande la brocha tiende a girar en sentido contrario al de la pieza, generando un brochado en espiral. Para evitar este problema es necesario el uso de la varilla como tope para forzar que el punzón gire simultaneo a la pieza a brochar.

#### 3. Brochados hasta el fondo de un agujero ciego.

Cuando se requiere que el brochado se realice hasta el fondo de un agujero ciego y no hay posibilidad de hacer un pretaladrado más profundo donde se depositen las virutas, es necesario ir progresivamente sacando dichas virutas amontonadas frente al punzón. Para retirar las virutas hay que sacar el punzón, volver a introducir la broca con la que se ha mecanizado el agujero previo y volver a introducir el punzón para seguir brochando. Pero dado que el punzón gira libremente, la manera de asegurarnos que el punzón va a reentrar en la misma posición que cuando salió es necesario el uso de la varilla de posicionado.

#### 4. Brochados en materiales duros.

Hay aplicaciones en las que, debido a la excesiva sección a cortar, a la excesiva profundidad del brochado o a la dureza del material, el brochado no se puede realizar de una sola vez ya que las virutas acumuladas llegan a cegar el agujero e impiden el avance de la brocha. En estos casos es necesario repasar el agujero, retirar las virutas y posteriormente volver a brochar la profundidad restante. Para asegurarnos que en esa segunda pasada la brocha vaya a re-entrar en la misma posición del primer brochado es necesario el uso de la varilla de posicionado.

Además de la varilla de posicionado, se ha de colocar también un tope en el plato del torno o en la mesa del centro de mecanizado de manera que la varilla contacte con el tope justo antes de que el punzón entre en contacto con la pieza, frenando así la rotación del punzón en un punto concreto de la pieza.

### 6. Use of the positioning lever

Every POLIPROFILE toolholder is supplied with a positioning lever tool, which is to be used only in the following cases:

#### 1. When the profile needs to be aligned with a specific part of the workpiece.

The broach turns freely in the toolholder so it is impossible to control the position of the generated profile unless the positioning lever tool is used.

#### 2. To avoid the appearance of inner spirals while broaching deeply

In the case of internal broaching, when the depth to be broached is high, the broach tends to turn on the opposite sense of the workpiece creating a spiral broaching. We recommend the use of the positioning lever tool to force the broach to turn with the workpiece.

#### 3. Broaching to the bottom of a blind hole

When broaching to the bottom of a blind hole is required and it is impossible to pre-drill deep enough, you need to remove the metal chips progressively. In order to achieve this, introduce the drill with which the pre-hole has been pre-machined so the chips come out and then introduce the broach. Since the broach turns freely, the positioning lever needs to be used to make sure the broach is introduced in the same position as the previous time.

#### 4. Broaching on hard materials

There are times when, due to the excessive section to be cut, the excessive depth of the broaching or the hardness of the material, the broaching procedure cannot be achieved in a single time, because the metal chips block the hole and do not allow the broach to go deeper. In these cases, it is necessary to introduce again the drill, remove the chips and broach finally to the desired depth. In order to make sure you reenter the hole in the same position, you need to use the positioning lever.

In addition to the positioning lever, it is also required to put a stop on the lathe chuck or at the table of the machining center so that the lever contact with the stop just before the broach comes into contact with the workpiece, braking thus the rotation of the broach at a particular point of the workpiece.



# BROCHADO ROTATORIO

## ROTARY BROACHING





# BROCHADO ROTATORIO ROTARY BROACHING



## MANGO CILÍNDRICO · CYLINDRICAL SHANK

### + Características

- Utilizable tanto en tornos como en centros de mecanizado y/o taladros
- Minimiza el esfuerzo de brochado gracias al sistema oscilatorio
- Rodamientos de alta gama que garantizan una larga vida de la herramienta
- Cuerpo estanco para evitar que las virutas penetren en la zona de los rodamientos
- Regulación de la posición del punzón mediante un tope regulable situado en el fondo del alojamiento del portabrochas
- Posibilidad de montar un portamatrix frontal para la realización de brochados externos

### + Features

- Usable in all types of lathes, machining centers, milling machines or drilling machines
- Minimizes broach load thanks to the pendular system
- High quality bearings to ensure a long tool life
- Dust-tight body to prevent chips from entering the bearing area
- Adjustment of the position of the broach by an adjustable stop located at the bottom of the broach holder
- Possibility to fit a frontal die-holder for external broaching



#### > POLIPROFILE 1

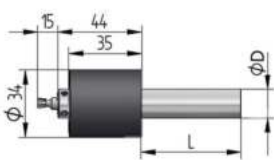

#### > POLIPROFILE 2

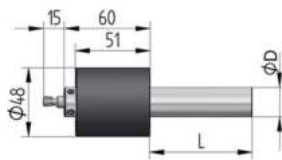

#### > POLIPROFILE 3

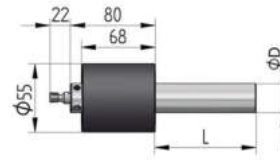

#### > POLIPROFILE 4

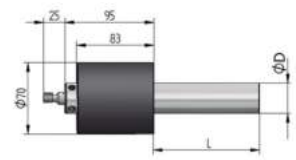

### Herramienta | Tool

Código Code	Referencia Reference	Capacidad Capacity	Punzón Broach	øD	L	Kg
06010106	Poliprofile1+C10	■<5 ●<6 mm	P-0828-/POL2	10 mm	40 mm	0,3
06010104	Poliprofile1+C12	■<5 ●<6 mm	P-0828-/POL2	12 mm	40 mm	0,3
06010103	Poliprofile1+C16	■<5 ●<6 mm	P-0828-/POL2	16 mm	70 mm	0,4
06010102	Poliprofile1+C3/4"	■<5 ●<6 mm	P-0828-/POL2	19.05 mm	70 mm	0,5
06010107	Poliprofile1+C20	■<5 ●<6 mm	P-0828-/POL2	20 mm	70 mm	0,5
06010203	Poliprofile2+C16	■<8 ●<10 mm	P-0828-/POL2	16 mm	70 mm	0,8
06010209	Poliprofile2+C3/4"	■<8 ●<10 mm	P-0828-/POL2	19.05 mm	70 mm	1
06010225	Poliprofile2+C2040	■<8 ●<10 mm	P-0828-/POL2	20 mm	40 mm	1
06010204	Poliprofile2+C20	■<8 ●<10 mm	P-0828-/POL2	20 mm	70 mm	0,8
06010303	Poliprofile3+C16	■<10 ●<14 mm	P-1045-/POL3	16 mm	70 mm	1,3
06010310	Poliprofile3+C3/4"	■<10 ●<14 mm	P-1045-/POL3	19.05 mm	70 mm	1,4
06010304	Poliprofile3+C20	■<10 ●<14 mm	P-1045-/POL3	20 mm	70 mm	1,4
06010326	Poliprofile3+C2240	■<10 ●<14 mm	P-1045-/POL3	22 mm	40 mm	1,4
06010305	Poliprofile3+C25	■<10 ●<14 mm	P-1045-/POL3	25 mm	90 mm	1,5
06010311	Poliprofile3+C1"	■<16 ●<24 mm	P-1650-/POL4	25.4 mm	70 mm	1,3
06010425	Poliprofile4+C3/4"	■<16 ●<24 mm	P-1650-/POL4	19.05 mm	90 mm	1,3
06010426	Poliprofile4+C2240	■<16 ●<24 mm	P-1650-/POL4	22 mm	40 mm	2,1
06010403	Poliprofile4+C25	■<16 ●<24 mm	P-1650-/POL4	25 mm	90 mm	2,2
06010411	Poliprofile4+C1"	■<16 ●<24 mm	P-1650-/POL4	25.4 mm	90 mm	2,2
06010404	Poliprofile4+C32	■<16 ●<24 mm	P-1650-/POL4	32 mm	90 mm	2,5
06010405	Poliprofile4+C40	■<16 ●<24 mm	P-1650-/POL4	40 mm	90 mm	2,7

### Portamatrix para brochado externo Die holder for external broaching

Código Code	Referencia Reference
06060100	POL1-PTM
06060200	POL2-PTM
06060300	POL3-PTM
06060400	POL4-PTM





# BROCHADO ROTATORIO ROTARY BROACHING



## WELDON DIN 1835-B

### + Características

- Utilizable tanto en tornos como en centros de mecanizado y/o taladros
- Minimiza el esfuerzo de brochado gracias al sistema oscilatorio
- Rodamientos de alta gama que garantizan una larga vida de la herramienta
- Cuerpo estanco para evitar que las virutas penetren en la zona de los rodamientos
- Regulación de la posición del punzón mediante un tope regulable situado en el fondo del alojamiento del portabrochas
- Posibilidad de montar un portamatriz frontal para la realización de brochados externos

### + Features

- Usable in all types of lathes, machining centers, milling machines or drilling machines
- Minimizes broach load thanks to the pendular system
- High quality bearings to ensure a long tool life
- Dust-tight body to prevent chips from entering the bearing area
- Adjustment of the position of the broach by an adjustable stop located at the bottom of the broach holder
- Possibility to fit a frontal die-holder for external broaching



#### > POLIPROFILE 1

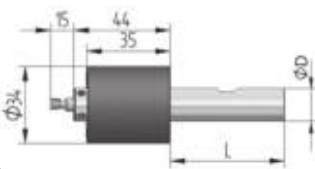

#### > POLIPROFILE 2

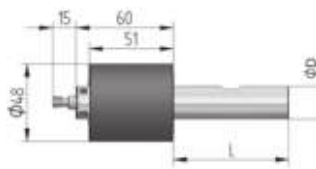

#### > POLIPROFILE 3

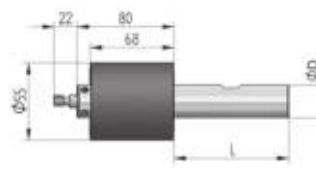

#### > POLIPROFILE 4

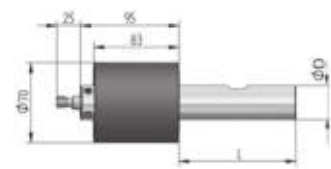

Herramienta   Tool						
Código Code	Referencia Reference	Capacidad Capacity	Punzón Broach	ØD	L	Kg
06010109	POLIPROFILE1+W10	■<5    ●<6 mm	P-0828 / POL2	10 mm	36 mm	0,3
06010108	POLIPROFILE1+W12	■<5    ●<6 mm	P-0828 / POL2	12 mm	41 mm	0,3
06010105	POLIPROFILE1+W16	■<5    ●<6 mm	P-0828 / POL2	16 mm	44 mm	0,4
06010110	POLIPROFILE1+W20	■<5    ●<6 mm	P-0828 / POL2	20 mm	46 mm	0,5
06010205	POLIPROFILE2+W16	■<8    ●<10 mm	P-0828 / POL2	16 mm	52 mm	0,8
06010206	POLIPROFILE2+W20	■<8    ●<10 mm	P-0828 / POL2	20 mm	52 mm	1
06010306	POLIPROFILE3+W20	■<10    ●<14 mm	P-1045 / POL2	20 mm	52 mm	1,4
06010307	POLIPROFILE3+W25	■<10    ●<14 mm	P-1045 / POL2	25 mm	59 mm	1,5
06010406	POLIPROFILE4+W25	■<16    ●<24 mm	P-1650 / POL4	25 mm	59 mm	2,2
06010407	POLIPROFILE4+W32	■<16    ●<24 mm	P-1650 / POL4	32 mm	63 mm	2,5

Portamatriz para brochado externo Die holder for external broaching	
Código Code	Referencia Reference
06060100	POL1-PTM
06060200	POL2-PTM
06060300	POL3-PTM
06060400	POL4-PTM







# BROCHADO ROTATORIO ROTARY BROACHING



## VDI DIN 69880

### + Características

- Utilizable tanto en tornos como en centros de mecanizado y/o taladros
- Minimiza el esfuerzo de brochado gracias al sistema oscilatorio
- Rodamientos de alta gama que garantizan una larga vida de la herramienta
- Cuerpo estanco para evitar que las virutas penetren en la zona de los rodamientos
- Regulación de la posición del punzón mediante un tope regulable situado en el fondo del alojamiento del portabrochas
- Posibilidad de montar un portamatriz frontal para la realización de brochados externos



### + Features

- Usable in all types of lathes, machining centers, milling machines or drilling machines
- Minimizes broach load thanks to the pendular system
- High quality bearings to ensure a long tool life
- Dust-tight body to prevent chips from entering the bearing area
- Adjustment of the position of the broach by an adjustable stop located at the bottom of the broach holder
- Possibility to fit a frontal die-holder for external broaching

#### > POLIPROFILE 2

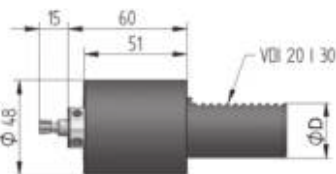

#### > POLIPROFILE 3

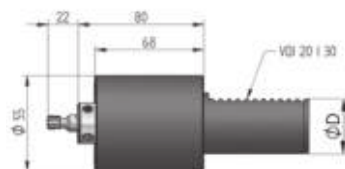

#### > POLIPROFILE 4

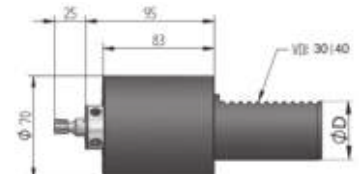

#### Herramienta | Tool

Código Code	Referencia Reference	Capacidad Capacity	Punzón Broach	$\phi D$	Kg
06010207	POLIPROFILE2+VDI20	■ <8    ● <10 mm	P-0828 / POL2	20 mm	0,9
06010208	POLIPROFILE2+VDI30	■ <8    ● <10 mm	P-0828 / POL2	30 mm	1
06010308	POLIPROFILE3+VDI20	■ <10    ● <14 mm	P-1045 / POL3	20 mm	1,4
06010309	POLIPROFILE3+VDI30	■ <10    ● <14 mm	P-1045 / POL3	30 mm	1,6
06010408	POLIPROFILE4+VDI30	■ <16    ● <24 mm	P-1650 / POL4	30 mm	2,1
06010409	POLIPROFILE4+VDI40	■ <16    ● <24 mm	P-1650 / POL4	40 mm	2,4

#### Portamatriz para brochado externo Die holder for external broaching

Código Code	Referencia Reference
06060200	POL2-PTM
06060300	POL3-PTM
06060400	POL4-PTM





# BROCHADO ROTATORIO ROTARY BROACHING



## PUNZONES HEXAGONALES HEXAGONAL BROACHES

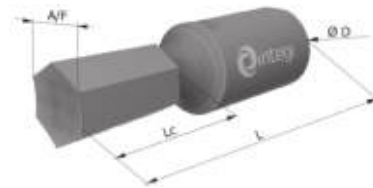
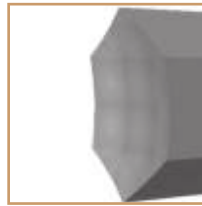

Código Code	Referencia Reference	A/F (mm)	Tolerancia (mm) Tolerance (mm)	øD (mm)	L (mm)	Lc (mm)	Para cabezal For broaching head
07010101	P-0828-H1.2	1.2	+0,02 / +0,05	ø8	28	1.8	POLIPROFILE 1&2
07010102	P-0828-H1.5	1.5	+0,02 / +0,05	ø8	28	2.3	POLIPROFILE 1&2
07010103	P-0828-H2.0	2	+0,02 / +0,05	ø8	28	3.0	POLIPROFILE 1&2
07010104	P-0828-H2.5	2.5	+0,02 / +0,05	ø8	28	3.8	POLIPROFILE 1&2
07010105	P-0828-H3.0	3	+0,02 / +0,05	ø8	28	4.6	POLIPROFILE 1&2
07010106	P-0828-H4.0	4	+0,02 / +0,05	ø8	28	6.0	POLIPROFILE 1&2
07010107	P-0828-H5.0	5	+0,04 / +0,07	ø8	28	8.6	POLIPROFILE 1&2
07010108	P-0828-H6.0	6	+0,04 / +0,07	ø8	28	9.0	POLIPROFILE 1&2
07010109	P-0828-H7.0	7	+0,04 / +0,07	ø8	28	10.0	POLIPROFILE 1&2
07010110	P-0828-H8.0	8	+0,04 / +0,07	ø8	28	10.8	POLIPROFILE 1&2
07010111	P-0828-H9.0	9	+0,04 / +0,07	ø8	28	13.2	POLIPROFILE 1&2
07010112	P-0828-H10	10	+0,05 / +0,09	ø8	28	11.8	POLIPROFILE 1&2

Código Code	Referencia Reference	A/F (mm)	Tolerancia (mm) Tolerance (mm)	øD (mm)	L (mm)	Lc (mm)	Para cabezal For broaching head
07020101	P-1045-H1.2	1.2	+0,02 / +0,05	ø10	45	1.8	POLIPROFILE 3
07020102	P-1045-H1.5	1.5	+0,02 / +0,05	ø10	45	2.3	POLIPROFILE 3
07020103	P-1045-H2.0	2	+0,02 / +0,05	ø10	45	3.0	POLIPROFILE 3
07020104	P-1045-H2.5	2.5	+0,02 / +0,05	ø10	45	3.8	POLIPROFILE 3
07020105	P-1045-H3.0	3	+0,02 / +0,05	ø10	45	4.6	POLIPROFILE 3
07020106	P-1045-H4.0	4	+0,02 / +0,05	ø10	45	6.0	POLIPROFILE 3
07020107	P-1045-H5.0	5	+0,04 / +0,07	ø10	45	8.0	POLIPROFILE 3
07020108	P-1045-H6.0	6	+0,04 / +0,07	ø10	45	9.0	POLIPROFILE 3
07020109	P-1045-H7.0	7	+0,04 / +0,07	ø10	45	10.0	POLIPROFILE 3
07020110	P-1045-H8.0	8	+0,04 / +0,07	ø10	45	12.4	POLIPROFILE 3
07020111	P-1045-H9.0	9	+0,04 / +0,07	ø10	45	13.4	POLIPROFILE 3
07020112	P-1045-H10	10	+0,05 / +0,09	ø10	45	15.0	POLIPROFILE 3
07020113	P-1045-H11	11	+0,05 / +0,09	ø10	45	15.4	POLIPROFILE 3
07020114	P-1045-H12	12	+0,05 / +0,09	ø10	45	16.4	POLIPROFILE 3
07020115	P-1045-H14	14	+0,05 / +0,09	ø10	45	15.6	POLIPROFILE 3

Código Code	Referencia Reference	A/F (mm)	Tolerancia (mm) Tolerance (mm)	øD (mm)	L (mm)	Lc (mm)	Para cabezal For broaching head
07040101	P-1650-H2.5	2.5	+0,02 / +0,05	ø16	50	4.0	POLIPROFILE 4
07040102	P-1650-H3.0	3	+0,02 / +0,05	ø16	50	4.6	POLIPROFILE 4
07040103	P-1650-H4.0	4	+0,02 / +0,05	ø16	50	6.0	POLIPROFILE 4
07040104	P-1650-H5.0	5	+0,04 / +0,07	ø16	50	8.0	POLIPROFILE 4
07040105	P-1650-H6.0	6	+0,04 / +0,07	ø16	50	9.4	POLIPROFILE 4
07040106	P-1650-H8.0	8	+0,04 / +0,07	ø16	50	13.0	POLIPROFILE 4
07040107	P-1650-H10	10	+0,05 / +0,09	ø16	50	15.4	POLIPROFILE 4
07040108	P-1650-H12	12	+0,05 / +0,09	ø16	50	17.0	POLIPROFILE 4
07040109	P-1650-H14	14	+0,05 / +0,09	ø16	50	18.6	POLIPROFILE 4
07040110	P-1650-H16	16	+0,05 / +0,09	ø16	50	19.0	POLIPROFILE 4
07040111	P-1650-H17	17	+0,05 / +0,09	ø16	50	22.0	POLIPROFILE 4
07040112	P-1650-H18	18	+0,05 / +0,09	ø16	50	22.0	POLIPROFILE 4
07040113	P-1650-H19	19	+0,05 / +0,09	ø16	50	19.7	POLIPROFILE 4
07040114	P-1650-H22	22	+0,05 / +0,09	ø16	50	20.0	POLIPROFILE 4
07040115	P-1650-H24	24	+0,05 / +0,09	ø16	50	20.6	POLIPROFILE 4

Código Code	Referencia Reference	A/F (mm)	Tolerancia (mm) Tolerance (mm)	øD (mm)	L (mm)	Lc (mm)	Para cabezal For broaching head
07030101	P-1255-H1.5	1.5	+0,02 / +0,05	ø12	55	2.3	-
07030102	P-1255-H2.0	2	+0,02 / +0,05	ø12	55	3	-
07030103	P-1255-H2.5	2.5	+0,02 / +0,05	ø12	55	3.8	-
07030104	P-1255-H3.0	3	+0,02 / +0,05	ø12	55	4.6	-
07030105	P-1255-H4.0	4	+0,02 / +0,05	ø12	55	6	-
07030106	P-1255-H5.0	5	+0,04 / +0,07	ø12	55	8	-
07030107	P-1255-H6.0	6	+0,04 / +0,07	ø12	55	9	-
07030108	P-1255-H7.0	7	+0,04 / +0,07	ø12	55	10	-
07030109	P-1255-H8.0	8	+0,04 / +0,07	ø12	55	12.4	-
07030110	P-1255-H9.0	9	+0,04 / +0,07	ø12	55	13.4	-
07030111	P-1255-H10	10	+0,05 / +0,09	ø12	55	15	-
07030112	P-1255-H11	11	+0,05 / +0,09	ø12	55	15.4	-
07030113	P-1255-H12	12	+0,05 / +0,09	ø12	55	16.4	-
07030114	P-1255-H13	13	+0,05 / +0,09	ø12	55	17.4	-
07030115	P-1255-H14	14	+0,05 / +0,09	ø12	55	18.6	-
07030116	P-1255-H15	15	+0,05 / +0,09	ø12	55	19	-
07030117	P-1255-H16	16	+0,05 / +0,09	ø12	55	19	-



# BROCHADO ROTATORIO ROTARY BROACHING



## PUNZONES HEXAGONALES EN PULGADAS HEXAGONAL BROACHES IN INCHES

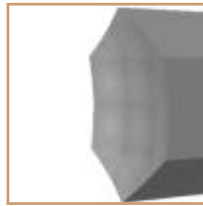

Código Code	Referencia Reference	(mm)	A/F Pulgadas Inches	Tolerancia (mm) Tolerance (mm)	ØD (mm)	L (mm)	Lc (mm)	Para cabezal For broaching head
07010113	P-0828-H1/16"	1,59	1/16"	+0,02/+0,05	Ø8	28	3,0	POLIPROFILE 1 & 2
07010114	P-0828-H5/64"	1,98	5/64"	+0,02/+0,05	Ø8	28	3,0	POLIPROFILE 1 & 2
07010115	P-0828-H3/32"	2,38	3/32"	+0,02/+0,05	Ø8	28	3,8	POLIPROFILE 1 & 2
07010116	P-0828-H7/64"	2,78	7/64"	+0,02/+0,05	Ø8	28	4,6	POLIPROFILE 1 & 2
07010117	P-0828-H1/8"	3,18	1/8"	+0,02/+0,05	Ø8	28	6,0	POLIPROFILE 1 & 2
07010118	P-0828-H9/64"	3,57	9/64"	+0,02/+0,05	Ø8	28	6,0	POLIPROFILE 1 & 2
07010119	P-0828-H5/32"	3,97	5/32"	+0,02/+0,05	Ø8	28	6,0	POLIPROFILE 1 & 2
07010120	P-0828-H11/64"	4,37	11/64"	+0,04/+0,07	Ø8	28	8,6	POLIPROFILE 1 & 2
07010121	P-0828-H3/16"	4,76	3/16"	+0,04/+0,07	Ø8	28	8,6	POLIPROFILE 1 & 2
07010122	P-0828-H7/32"	5,56	7/32"	+0,04/+0,07	Ø8	28	9,0	POLIPROFILE 1 & 2
07010123	P-0828-H1/4"	6,35	1/4"	+0,04/+0,07	Ø8	28	10,0	POLIPROFILE 1 & 2

Código Code	Referencia Reference	(mm)	A/F Pulgadas Inches	Tolerancia (mm) Tolerance (mm)	ØD (mm)	L (mm)	Lc (mm)	Para cabezal For broaching head
07020116	P-1045-H1/16"	1,59	1/16"	+0,02/+0,05	Ø10	45	3,0	POLIPROFILE 3
07020117	P-1045-H5/64"	1,98	5/64"	+0,02/+0,05	Ø10	45	3,0	POLIPROFILE 3
07020118	P-1045-H3/32"	2,38	3/32"	+0,02/+0,05	Ø10	45	3,8	POLIPROFILE 3
07020119	P-1045-H7/64"	2,78	7/64"	+0,02/+0,05	Ø10	45	4,6	POLIPROFILE 3
07020120	P-1045-H1/8"	3,18	1/8"	+0,02/+0,05	Ø10	45	6,0	POLIPROFILE 3
07020121	P-1045-H9/64"	3,57	9/64"	+0,02/+0,05	Ø10	45	6,0	POLIPROFILE 3
07020122	P-1045-H5/32"	3,97	5/32"	+0,02/+0,05	Ø10	45	6,0	POLIPROFILE 3
07020123	P-1045-H11/64"	4,37	11/64"	+0,04/+0,07	Ø10	45	8,6	POLIPROFILE 3
07020124	P-1045-H3/16"	4,76	3/16"	+0,04/+0,07	Ø10	45	8,6	POLIPROFILE 3
07020125	P-1045-H7/32"	5,56	7/32"	+0,04/+0,07	Ø10	45	9,0	POLIPROFILE 3
07020126	P-1045-H1/4"	6,35	1/4"	+0,04/+0,07	Ø10	45	10,0	POLIPROFILE 3
07020127	P-1045-H5/16"	7,94	5/16"	+0,04/+0,07	Ø10	45	12,4	POLIPROFILE 3
07020128	P-1045-H3/8"	9,53	3/8"	+0,04/+0,07	Ø10	45	15,0	POLIPROFILE 3
07020129	P-1045-H7/16"	11,11	7/16"	+0,04/+0,07	Ø10	45	16,4	POLIPROFILE 3
07020130	P-1045-H1/2"	12,70	1/2"	+0,05/+0,09	Ø10	45	15,6	POLIPROFILE 3

Código Code	Referencia Reference	(mm)	A/F Pulgadas Inches	Tolerancia (mm) Tolerance (mm)	ØD (mm)	L (mm)	Lc (mm)	Para cabezal For broaching head
07040116	P-1650-H3/32"	2,38	3/32"	+0,02/+0,05	Ø16	50	3,8	POLIPROFILE 4
07040117	P-1650-H7/64"	2,78	7/64"	+0,02/+0,05	Ø16	50	4,6	POLIPROFILE 4
07040118	P-1650-H1/8"	3,18	1/8"	+0,02/+0,05	Ø16	50	6,0	POLIPROFILE 4
07040119	P-1650-H9/64"	3,57	9/64"	+0,02/+0,05	Ø16	50	6,0	POLIPROFILE 4
07040120	P-1650-H5/32"	3,97	5/32"	+0,02/+0,05	Ø16	50	6,0	POLIPROFILE 4
07040121	P-1650-H11/64"	4,37	11/64"	+0,04/+0,07	Ø16	50	8,6	POLIPROFILE 4
07040122	P-1650-H3/16"	4,76	3/16"	+0,04/+0,07	Ø16	50	8,6	POLIPROFILE 4
07040123	P-1650-H7/32"	5,57	7/32"	+0,04/+0,07	Ø16	50	9,0	POLIPROFILE 4
07040124	P-1650-H1/4"	6,35	1/4"	+0,04/+0,07	Ø16	50	10,0	POLIPROFILE 4
07040125	P-1650-H5/16"	7,94	5/16"	+0,04/+0,07	Ø16	50	12,4	POLIPROFILE 4
07040126	P-1650-H3/8"	9,53	3/8"	+0,04/+0,07	Ø16	50	15,0	POLIPROFILE 4
07040127	P-1650-H1/2"	12,70	1/2"	+0,05/+0,09	Ø16	50	15,6	POLIPROFILE 4
07040128	P-1650-H9/16"	14,29	9/16"	+0,05/+0,09	Ø16	50	19,0	POLIPROFILE 4
07040129	P-1650-H5/8"	15,88	5/8"	+0,05/+0,09	Ø16	50	19,0	POLIPROFILE 4
07040130	P-1650-H3/4"	19,05	3/4"	+0,05/+0,09	Ø16	50	20,0	POLIPROFILE 4
07040131	P-1650-H7/8"	22,23	7/8"	+0,05/+0,09	Ø16	50	20,06	POLIPROFILE 4

Código Code	Referencia Reference	(mm)	A/F Pulgadas Inches	Tolerancia (mm) Tolerance (mm)	ØD (mm)	L (mm)	Lc (mm)	Para cabezal For broaching head
07030118	P-1255-H1/16"	1,59	1/16"	+0,02/+0,05	Ø12	55	3,0	-
07030119	P-1255-H5/64"	1,98	5/64"	+0,02/+0,05	Ø12	55	3,0	-
07030120	P-1255-H3/32"	2,38	3/32"	+0,02/+0,05	Ø12	55	3,8	-
07030121	P-1255-H7/64"	2,78	7/64"	+0,02/+0,05	Ø12	55	4,6	-
07030122	P-1255-H1/8"	3,18	1/8"	+0,02/+0,05	Ø12	55	6,0	-
07030123	P-1255-H9/64"	3,57	9/64"	+0,02/+0,05	Ø12	55	6,0	-
07030124	P-1255-H5/32"	3,97	5/32"	+0,02/+0,05	Ø12	55	6,0	-
07030125	P-1255-H11/64"	4,37	11/64"	+0,04/+0,07	Ø12	55	8,6	-
07030126	P-1255-H3/16"	4,76	3/16"	+0,04/+0,07	Ø12	55	8,6	-
07030127	P-1255-H7/32"	5,56	7/32"	+0,04/+0,07	Ø12	55	9,0	-
07030128	P-1255-H1/4"	6,35	1/4"	+0,04/+0,07	Ø12	55	10,0	-
07030129	P-1255-H5/16"	7,94	5/16"	+0,04/+0,07	Ø12	55	12,4	-
07030130	P-1255-H3/8"	9,53	3/8"	+0,04/+0,07	Ø12	55	15,0	-
07030131	P-1255-H7/16"	11,11	7/16"	+0,05/+0,09	Ø12	55	15,6	-
07030132	P-1255-H1/2"	12,70	1/2"	+0,05/+0,09	Ø12	55	15,6	-
07030133	P-1255-H9/16"	14,29	9/16"	+0,05/+0,09	Ø12	55	19,0	-
07030134	P-1255-H5/8"	15,88	5/8"	+0,05/+0,09	Ø12	55	19,0	-



## BROCHADO ROTATORIO ROTARY BROACHING



### PUNZONES CUADRADOS SQUARE BROACHES



Código Code	Referencia Reference	A/F (mm)	Tolerancia (mm) Tolerance (mm)	øD (mm)	L (mm)	Lc (mm)	Para cabezal For broaching head
07010201	P-0828-C1.2	1.2	+0,02 / +0,05	ø8	28	1.8	POLIPROFILE 1&2
07010202	P-0828-C1.5	1.5	+0,02 / +0,05	ø8	28	2.3	POLIPROFILE 1&2
07010203	P-0828-C2.0	2	+0,02 / +0,05	ø8	28	3	POLIPROFILE 1&2
07010204	P-0828-C3.0	3	+0,02 / +0,05	ø8	28	4.6	POLIPROFILE 1&2
07010205	P-0828-C4.0	4	+0,02 / +0,05	ø8	28	6	POLIPROFILE 1&2
07010206	P-0828-C5.0	5	+0,04 / +0,07	ø8	28	8.6	POLIPROFILE 1&2
07010207	P-0828-C6.0	6	+0,04 / +0,07	ø8	28	9	POLIPROFILE 1&2
07010208	P-0828-C7.0	7	+0,04 / +0,07	ø8	28	10	POLIPROFILE 1&2
07010209	P-0828-C8.0	8	+0,04 / +0,07	ø8	28	10.8	POLIPROFILE 1&2

Código Code	Referencia Reference	A/F (mm)	Tolerancia (mm) Tolerance (mm)	øD (mm)	L (mm)	Lc (mm)	Para cabezal For broaching head
07020201	P-1045-C1.2	1.2	+0,02 / +0,05	ø10	45	1.8	POLIPROFILE 3
07020202	P-1045-C1.5	1.5	+0,02 / +0,05	ø10	45	2.3	POLIPROFILE 3
07020203	P-1045-C2.0	2	+0,02 / +0,05	ø10	45	3	POLIPROFILE 3
07020204	P-1045-C2.5	2.5	+0,02 / +0,05	ø10	45	3.8	POLIPROFILE 3
07020205	P-1045-C3.0	3	+0,02 / +0,05	ø10	45	4.6	POLIPROFILE 3
07020206	P-1045-C4.0	4	+0,02 / +0,05	ø10	45	6	POLIPROFILE 3
07020207	P-1045-C5.0	5	+0,04 / +0,07	ø10	45	8	POLIPROFILE 3
07020208	P-1045-C6.0	6	+0,04 / +0,07	ø10	45	9	POLIPROFILE 3
07020209	P-1045-C7.0	7	+0,04 / +0,07	ø10	45	10	POLIPROFILE 3
07020210	P-1045-C8.0	8	+0,04 / +0,07	ø10	45	12.4	POLIPROFILE 3
07020211	P-1045-C9.0	9	+0,04 / +0,07	ø10	45	13.4	POLIPROFILE 3
07020212	P-1045-C10	10	+0,05 / + 0,09	ø10	45	15	POLIPROFILE 3

Código Code	Referencia Reference	A/F (mm)	Tolerancia (mm) Tolerance (mm)	øD (mm)	L (mm)	Lc (mm)	Para cabezal For broaching head
07040201	P-1650-C2.5	2.5	+0,02 / +0,05	ø16	50	3.8	POLIPROFILE 4
07040202	P-1650-C3.0	3	+0,02 / +0,05	ø16	50	4.6	POLIPROFILE 4
07040203	P-1650-C4.0	4	+0,02 / +0,05	ø16	50	6	POLIPROFILE 4
07040204	P-1650-C5.0	5	+0,04 / +0,07	ø16	50	8	POLIPROFILE 4
07040205	P-1650-C6.0	6	+0,04 / +0,07	ø16	50	9.4	POLIPROFILE 4
07040206	P-1650-C8.0	8	+0,04 / +0,07	ø16	50	13	POLIPROFILE 4
07040207	P-1650-C10	10	+0,05 / +0,09	ø16	50	15.4	POLIPROFILE 4
07040208	P-1650-C12	12	+0,05 / +0,09	ø16	50	17	POLIPROFILE 4
07040209	P-1650-C14	14	+0,05 / +0,09	ø16	50	18.6	POLIPROFILE 4



## BROCHADO ROTATORIO ROTARY BROACHING



### PUNZONES HEXALOBULARES HEXALOBULAR BROACHES

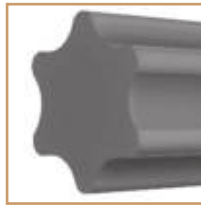

Código Code	Referencia Reference	E	øD (mm)	L (mm)	Lc (mm)	Para cabezal For broaching head
06050241	POL2-PT6	TORX 6	ø8 mm	28 mm	3 mm	POLIPROFILE 1 & 2
06050242	POL2-PT8	TORX 8	ø8 mm	28 mm	3.8 mm	POLIPROFILE 1 & 2
06050243	POL2-PT10	TORX 10	ø8 mm	28 mm	4.6 mm	POLIPROFILE 1 & 2
06050244	POL2-PT15	TORX 15	ø8 mm	28 mm	5.4 mm	POLIPROFILE 1 & 2
06050245	POL2-PT20	TORX 20	ø8 mm	28 mm	6.2 mm	POLIPROFILE 1 & 2

Código Code	Referencia Reference	E	øD (mm)	L (mm)	Lc (mm)	Para cabezal For broaching head
06050341	POL3-PT6	TORX 6	ø10 mm	45 mm	3 mm	POLIPROFILE 3
06050342	POL3-PT8	TORX 8	ø10 mm	45 mm	3.8 mm	POLIPROFILE 3
06050343	POL3-PT10	TORX 10	ø10 mm	45 mm	4.6 mm	POLIPROFILE 3
06050344	POL3-PT15	TORX 15	ø10 mm	45 mm	5.4 mm	POLIPROFILE 3
06050345	POL3-PT20	TORX 20	ø10 mm	45 mm	6.2 mm	POLIPROFILE 3
06050346	POL3-PT25	TORX 25	ø10 mm	45 mm	6.5	POLIPROFILE 3
06050347	POL3-PT30	TORX 30	ø10 mm	45 mm	7 mm	POLIPROFILE 3
06050348	POL3-PT40	TORX 40	ø10 mm	45 mm	8 mm	POLIPROFILE 3
06050349	POL3-PT45	TORX 45	ø10 mm	45 mm	9 mm	POLIPROFILE 3

Código Code	Referencia Reference	E	øD (mm)	L (mm)	Lc (mm)	Para cabezal For broaching head
06050441	POL4-PT10	TORX 10	ø16 mm	50 mm	4.6 mm	POLIPROFILE 4
06050442	POL4-PT15	TORX 15	ø16 mm	50 mm	5.4 mm	POLIPROFILE 4
06050443	POL4-PT20	TORX 20	ø16 mm	50 mm	6.2 mm	POLIPROFILE 4
06050444	POL4-PT25	TORX 25	ø16 mm	50 mm	6.5 mm	POLIPROFILE 4
06050445	POL4-PT30	TORX 30	ø16 mm	50 mm	7 mm	POLIPROFILE 4
06050446	POL4-PT40	TORX 40	ø16 mm	50 mm	8 mm	POLIPROFILE 4
06050447	POL4-PT45	TORX 45	ø16 mm	50 mm	9 mm	POLIPROFILE 4





[www.integi.com](http://www.integi.com)



Autonomía, 5  
E-48250 · Zaldibar · Bizkaia · Spain

Tel: +34 943 17 48 00

[integi@integi.com](mailto:integi@integi.com)



Miembro de / Member of:

